



Load Frequency Control Using Fuzzy Logic Based Controller for Multi-area Power System

D. K. Sambariya^{1*} and Vivek Nath¹

¹Department of Electrical Engineering, Rajasthan Technical University, Kota 324010, India.

Authors' contributions

This work was carried out in collaboration between both authors. Both authors read and approved the final manuscript.

Article Information

DOI: 10.9734/BJMCS/2016/22899

Editor(s):

(1) Feyzi Basar, Department of Mathematics, Fatih University, Turkey.

Reviewers:

(1) O. V. Singh, Maharishi Markandeshwar University, Haryana, India.

(2) Radek Matusu, Tomas Bata University in Zlin, Czech Republic.

(3) Anonymous, Spain.

(4) Anonymous, California Institute of Technology, California, USA.

Complete Peer review History: <http://sciencedomain.org/review-history/12821>

Original Research Article

Received: 4th November 2015

Accepted: 16th December 2015

Published: 28th December 2015

Abstract

Load frequency control (LFC) is required for reliable operation of a large interconnected power system. The main work of load frequency control is to regulate the power output of the generator within a specified area with respect to change in the system frequency and tie-line power; such as to maintain the scheduled system frequency and power interchange with other areas in a prescribe limits. In this paper, study of LFC system for single area and double area non-reheat thermal system is carried out. Fuzzy logic controller is used for controlling the frequency and tie-line power deviation. The robustness of the fuzzy logic controller is seen for different loading condition. Frequency and tie-line power response of the interconnected areas have been compared on the basis of peak-overshoot, peak-undershoot and settling time. The result of the fuzzy logic controller is compared to that of with classical controller such as proportional derivative plus integral (PID) controller, and it is found that the convention controller response is slow as compared to the intelligent controller.

*Corresponding author: E-mail: dsambariya_2003@yahoo.com;

Keywords: Load Frequency Control (LFC); Fuzzy Logic Control (FLC); Automatic Control Error (ACE); Proportional-Integral-Derivative (PID) controller.

Nomenclatures

R_1, R_2 represents the speed regulation.
 D_1, D_2 represents the frequency-sensitive load coefficient.
 H_1, H_2 represents inertia constant.
 T_{g1}, T_{g2} represents the governor time constant.
 T_{t1}, T_{t2} represents the turbine time constant.
 B_1, B_2 represents the frequency bias factors.

1 Introduction

The objective of the load frequency control (LFC) is to maintain the scheduled frequency and scheduled tie-line power in a normal mode of operation, during the small perturbation in operating conditions. It maintains the generator-demand of an area in a prescribed limit by adjusting the governor output [1, 2]. The large interconnected power systems are composed of control areas or regions, representing a coherent group of generators. The different areas are inter-connected through tie-lines. The tie-lines are utilized for exchanging the energy between the consecutive two-areas and provides inter-area support in case of abnormal conditions of the power system [3]. On occurrence of load change, the mismatch in frequency and scheduled power interchange between areas takes place in the system. This mismatch has to be corrected by load frequency control (LFC), which is defined as the regulation of power output of generators within a tolerable limit [4].

Number of conventional controller like PID, PI, I are used in a control system, as this controller is simple to implement, easy to understand and having low cost. Nature of their control strategy is reliable and reported as robust for some operating conditions. However, the response of system with these controllers is slow and poor in comparison to the intelligent controller [5].

Many control techniques have been reported in literature to control the frequency and tie-Line power in LFC system; like adaptive neuro fuzzy inference system (ANFIS), NARMAL-2 controller, etc [6, 7].

Zadeh introduced fuzzy set theory and the first fuzzy logic control algorithm was implemented by Mamdani on a steam engine [8, 9]. The large, complex and inter-connected power systems suffer with a large number of nonlinear properties therefore, fuzzy logic controller is one of the better controller these systems. In this paper, the fuzzy logic controller is used for control of load frequency of the system. The fuzzy logic controller is based on fuzzy set theory and being represented with the experience and knowledge of a human operator of the system [10, 11, 12, 13]. The fuzzy logic controller does not require mathematical knowledge of a system. On absorbing the system output/behaviour; the rules can be discussed and the number of membership function are defined as in [14, 15].

Many researchers have used conventional controller and optimal PID controller for controlling frequency deviation and Tie-Line power. In this paper a single and double area LFC is designed for frequency and power deviation control [16, 17]. The proposed Fuzzy logic gives the better results than the conventional controller Like PID; the intelligent controller results are compared with classical controller Using MATLAB software. The power deviation and frequency response obtained by the fuzzy logic controller in LFC are compared with LFC having PID controller in terms of settling time, rise time and peak-overshoot. It is found that fuzzy gives better result as compared to the conventional controller.

Nada and Mangal, (2004) have proposed work on fuzzy logic controller for automatic generation control of hydro-thermal plant system and the results have been compared that of with PI controller [3]. The robust fuzzy controller for uncertain non-linear power system have been presented in [18]. Yesil et al have proposed a self tuning fuzzy PID type controller for load frequency control problem and its result compare with conventional controller [2]. Sahu et al have presented load frequency controller for two area non-reheat turbine system and the PID controller parameters were optimized using Teachinglearning based optimization (TLBO) technique [19]. Ikhe and kulkarni (2013) have considered load frequency control using PID, PI, I controllers and compared the results [20]. Modi et al have proposed LFC design for Tie-Line and frequency control using particle swarm optimization (PSO) and genetic algorithm (GA) and compared that of with PI controller [21]. Recently, the application of particle swarm optimization to fuzzy logic controller have been presented for load frequency control in a smart grid [22]. The hierarchical control design and synthesis in the case where the collection of subsystems is comprised of fuzzy logic controllers, and fuzzy knowledge-based decision systems are well presented in [23]. It implements hierarchical behavior-based controllers for autonomous navigation of one or more mobile robots. The number of rules increases exponentially with the number of variables for FLC applications to large and complex systems. Hierarchical fuzzy systems are one of the alternatives to reduce the number of rules as presented in [24].

This Paper is organized in five sections. The section 2, introduces the modeling aspects of single-area and two-area power systems. Fuzzy Logic controller with its components is discussed in section 3. The results of system with proposed FLC and that of with PID controller presented by different researchers are compared in section 4. Finally the purpose is concluded in section 5; followed by appendix, nomenclature and references.

2 System for LFC

The reason of frequency drop is that the prime mover slows down to compensate for the imbalance in power, however, the speed is controlled by the power generation. As the speed change diminishes; the error signal becomes smaller, and the governor speed is made constant. However, it is impossible to fix the governor speed to a set point because the load is varying with time; therefore, we use a control system with an integrator. The control mechanism analyses the change and make corrections accordingly to remove offsets. The ability of the system to come back to its normal value is termed as reset point. Therefore, the AGC is a scheme which restores the frequency to its nominal value automatically. In Fig. 1 the AGC for single area is shown, the AGC consist of a governor system which provides a signal to the turbine to adjust its speed to maintain the frequency constant.

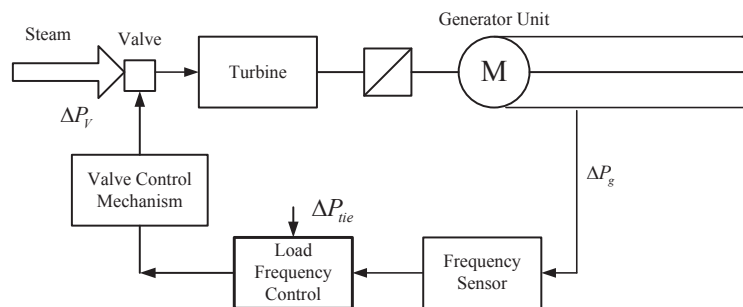

Fig. 1. Block diagram of automatic load frequency control

2.1 Modeling of single-area system

The main parts of the system consist of Governor, prime mover load and inertia model. These are described as following:

- *Governor model:* The command ΔP_g is transformed by hydraulic amplifier to the steam valve position ΔP_v . The T_g is governor time constant, the transfer function of governor is given in Eqn. 2.1.

$$\frac{\Delta P_v(s)}{\Delta P_g(s)} = \frac{1}{1 + T_g s} \quad (2.1)$$

- *Prime mover model:* The prime mover is used for producing mechanical power; it may be steam for steam turbine, water wall for hydraulic turbine. The model of prime mover ΔP_m relates the mechanical power output to change in steam valve ΔP_v value the transfer function is given in Eqn. 2.2.

$$\frac{\Delta P_m(s)}{\Delta P_v(s)} = \frac{1}{1 + T_t s} \quad (2.2)$$

- *Load and inertia model:* The motor load is sensitive to the frequency change and can be analysed by speed load characteristic as given in Eqn. 2.3.

$$\frac{\Delta w(s)}{\Delta P_m - \Delta P_l} = \frac{1}{2H + D} \quad (2.3)$$

- *Frequency bias factor:* The frequency biased factor is sum of frequency sensitive load change (D) and speed regulation as given in Eqn. 2.4.

$$B = \frac{1}{R} + D \quad (2.4)$$

The block diagram of the system can be presented using Eqn. 2.1 to Eqn. 2.4 and is shown in Fig. 2.

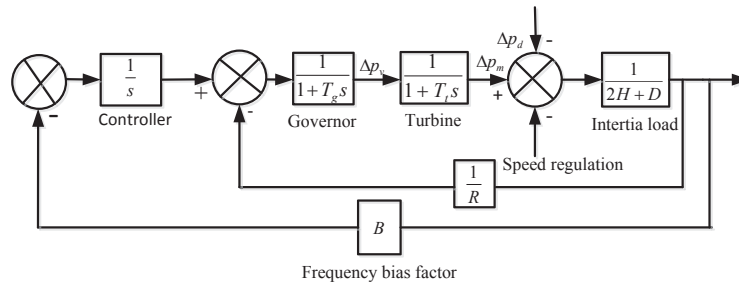

Fig. 2. Block diagram of load frequency control for single area system

2.2 Modeling of two-area system

A two-area system is represented by an equivalent generating unit interconnected by a lossless tie line with reactance of X_{tie} in Fig. 3.

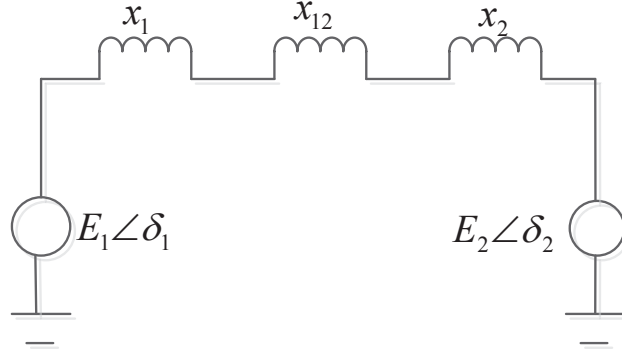

Fig. 3. Representation of two-area system

The real power transferred over the tie-line during normal operating conditions is given by Eqn. 2.5.

$$P_{12} = \frac{|E_1||E_2|}{X_{12}} \sin \Delta\delta_{12} \quad (2.5)$$

Consider a small deviation of rotor angle δ_0 the resulting tie line power ΔP_{12} is given by Eqn. 2.6.

$$\Delta P_{12} = \frac{\partial P_{12}}{\partial \delta_{12}} \quad (2.6)$$

The synchronous power coefficient is given by Eqn. 2.7.

$$P_S = \frac{|E_1||E_2|}{X_{12}} \cos \Delta\delta_{12} \quad (2.7)$$

Considering a load change ΔP_{L1} in area-1 at the time of steady state in frequency. It results as $\Delta w = \Delta w_1 = \Delta w_2$.

$$\begin{aligned} \Delta P_{m1} - \Delta P_{m2} - \Delta P_{t1} &= \Delta\omega D_1 \\ \Delta P_{m2} + \Delta P_{12} &= \Delta\omega D_2 \end{aligned} \quad (2.8)$$

The change in mechanical power is determined by using the governor speed characteristic and is given as

$$\begin{aligned} \Delta P_{m1} &= \frac{-\Delta\omega}{R_1} \\ \Delta P_{m2} &= \frac{-\Delta\omega}{R_2} \end{aligned} \quad (2.9)$$

$$\begin{aligned} \Delta\omega &= \frac{-\Delta P_{t1}}{B_1 + B_2} \\ \Delta P_{12} &= \frac{B_2}{B_1 + B_2} (-\Delta P_{t1}) \end{aligned} \quad (2.10)$$

2.2.1 Tie-line bias control

The tie-line bias control is used to maintain frequency and power at a pre-specified value where in each area manages its own load. The conventional LFC is based on the tie line bias control; in which each area is trying to reduce error to zero. The area control error is given by (ACE).

$$\begin{aligned} ACE_1 &= \Delta P_{12} + B_1 \Delta\omega_1 \\ ACE_2 &= \Delta P_{21} + B_2 \Delta\omega_2 \end{aligned} \quad (2.11)$$

By using the above Eqn. 2.11, the block diagram can be made as given below of a two area interconnected power system is shown in Fig. 4.

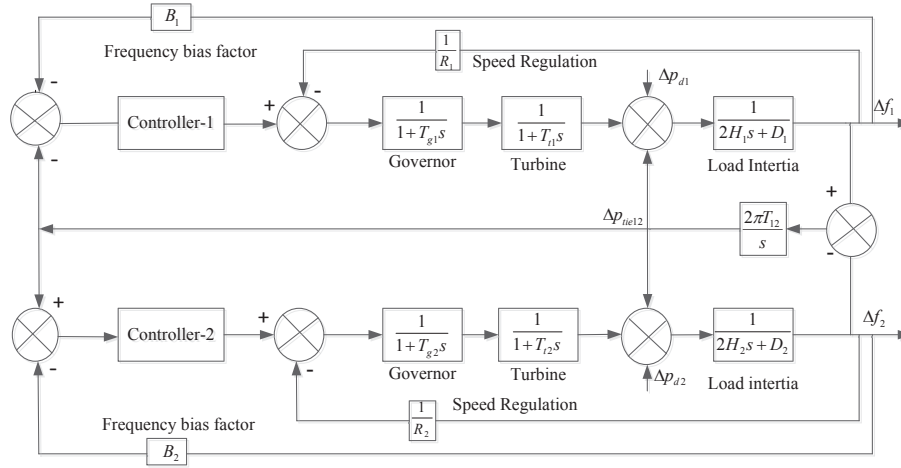

Fig. 4. Block diagram of two-area interconnected system

In this paper, a single area system and an interconnected power system with two-areas have taken into consideration. The system model consists of a governor, non reheat turbine and load-inertia in a transfer function form and speed regulation constant and frequency bias factor are the feedback to the frequency output, there is a frequency deviation in isolated system given as Δf , in two-area system are two frequency deviation Δf_1 for area-1 and Δf_2 for area-2. The power demand increment for area-1 is ΔP_{d1} and for area-2 is ΔP_{d2} , this power demand is given in step load form. The area control error (ACE) for the two area is given two the controller. The fuzzy logic controller is used for controlling the frequency and power deviation in single and two are system. Designed fuzzy logic controller has forty nine rules and seven membership functions are used for each input and output. The triangular membership function is used for the controller and centroid method is used for defuzzification [13, 14].

3 Fuzzy Logic Controller

The fuzzy logic controller is based on fuzzy logic and provides an algorithm which converts the linguistic control strategy based on expert knowledge into an automatic control strategy [18, 25]. By complex control technique it is difficult to analysis complex problem [15]. Fuzzy logic controller are mainly useful, whenever the source of information is uncertain or not exact [12, 13]. It consist of four components, different part of fuzzy control is given in Fig. 5.

- *Fuzzification*: is related to the indefinite and indeterminate in a natural language. In fuzzy control application the observed data are usually crisp [26]. The data manipulation in an fuzzy logic controller is based on fuzzy set theory, fuzzification is necessary in an earlier stage [27]. Following function is performed by fuzzification, it measures the values of input variables and it performs a scale mapping that transforms the range of values of input variables into corresponding universe or discourse. Performance the function of fuzzification that converts input into suitable linguistic values, which may be viewed labels of fuzzy sets [28, 29]. For LFC triangular membership function is used.
- *Knowledge base*: The knowledge base of a FLC consists of a database and a rule base. The basic function of a database is to provide necessary information for the proper functioning of the Fuzzification, the rule base, and the defuzzification. The data base gives information

about fuzzy sets representing the meaning of the linguistic values of the process and the control output variables [30]. Basic function of the rule base is to represent in a structure way the control policy of an experienced process operator and control engineer in the form of a set of production rules such as, If (process state) then (control output). The if part of such a rule is called rule antecedent and is a description of a process state in term of logical combination of atomic fuzzy propositions. The then part of rule is called rule consequent and is again the description of control output in terms of a logical combination of fuzzy proposition. These propositions state the linguistic values which the control outputs take when the current process state matches the process state description in the rule-antecedent [31]. Basically, fuzzy control rules provide a convenient way for expressing control policy and domain knowledge.

- *Fuzzy Inference System*: It is a way of mapping an input space to an output space using fuzzy logic .FIS uses a collection of fuzzy membership functions and rules, instead of Boolean logic, to reason about data [32]. Large neg (Ln), Medium neg (Mn), Small neg (Sn), Zero (Ze), Small pos (Sp), Medium pos (Mp), large positive (Lp). In Table 1, it can see the seven linguistic variables for input1error e and derivative of error Δe input-2 the linguistic variables are taken, and this linguistic variable are multiple with is other in the inference engine and forty nine rule are formed for LFC. In Defuzzification, the fuzzy output set is converted to a crisp number. Some commonly used techniques are the centroid and maximum methods. In the centroid method, the crisp value of the output variable is computed by finding the variable value of the centre of gravity of the membership function for the fuzzy value. In the maximum method, one of the variable values at which the fuzzy set has its maximum truth value is chosen as the crisp value for the output variable.
- A membership function (MF) is a curve that defines how each point in the input space is mapped to a membership value (or degree of membership) between 0 and 1. The input space is sometimes referred to as the universe of discourse. The simplest membership functions are formed using straight lines. Of these, the simplest is the triangular membership function, and it has the function name trimf. This function is nothing more than a collection of three points forming a triangle. The trapezoidal membership function, trapmf, has a flat top and really is just a truncated triangle curve. These straight line membership functions have the advantage of simplicity. In this paper seven triangular type membership functions for each input is taken which is shown below in Fig. 6.

Table 1. Rule base for load frequency control (LFC)

| Freq. devn. | Rate of change of freq. devn. | | | | | | |
|----------------|-------------------------------|----|----|----|----|----|----|
| | Ln | Mn | Sn | Ze | Lp | Mp | Sp |
| Ln | Ln | Ln | Mn | Ln | Mn | Sn | Ze |
| Mn | Ln | Ln | Ln | Mn | Sn | Ze | Mp |
| Sn | Ln | Ln | Mn | Sn | Ze | Lp | Mp |
| Ze | Ln | Mn | Sn | Ze | Lp | Mp | Sp |
| Lp | Mn | Sn | Ze | Lp | Mp | Sp | Sp |
| Mp | Sn | Ze | Lp | Mp | Sp | Sp | Sp |
| Sp | Ze | Mp | Mp | Sp | Sp | Sp | Sp |

Table 2. Frequency deviation (Δf) of single-area for LFC of proposed-fuzzy and PID

| Controller | Settling Time | Undershoot |
|------------------|---------------|------------------------|
| Fuzzy (Proposed) | 13 | -4.03×10^{-4} |
| PID [21] | 28 | -2.85×10^{-4} |
| PID [33] | 18 | -2.45×10^{-4} |
| PID [16] | - | -7.2×10^{-4} |
| PID [34] | 28 | -6.9×10^{-4} |
| PID [35] | - | -7.3×10^{-4} |

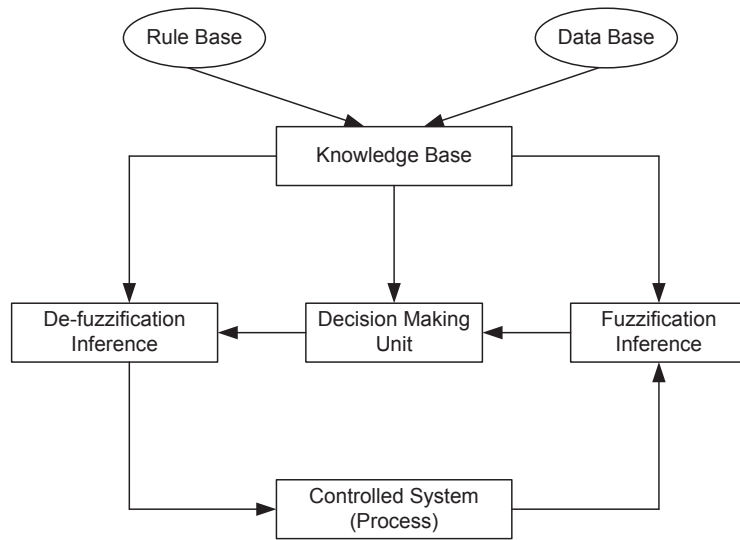

Fig. 5. Block diagram representation of fuzzy logic controller

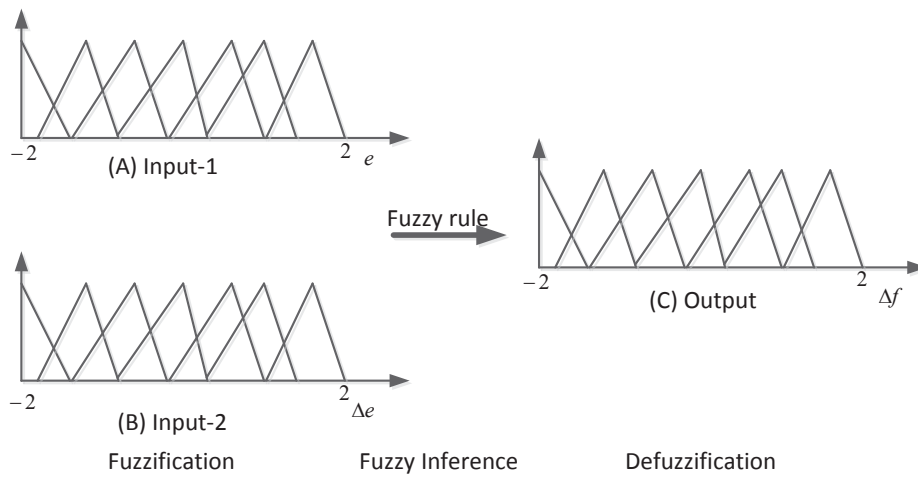

Fig. 6. Membership function for load frequency control

4 Results and Discussion

Simulations were performed using MATLAB and Simulink in connection with fuzzy logic tool box. In this paper, the study of load frequency control (LFC) is carried out for single-area and two-area model of non-reheat turbine power systems using fuzzy logic controller. The disturbance of 0.01 p.u. is given to both of the areas in two-area system. Data used for interconnected two-area system are given in Appendix. However, the data for single-area power system have been considered as that of the data for area-1 in the interconnected system as given in Appendix. Data for single-area power system is similar to area-1 data as given in Appendix.

4.1 Single-area system

In isolated system (single-area), frequency (Δf) is controlled using fuzzy logic controller. The robust operation of single-area system with FLC is considered for different loading conditions as shown in Fig. 7. Here, the step load is varied for wide range of operating conditions [36]. Comparison of frequency response of the system with proposed fuzzy logic controller and that of with conventional PID controllers as reported in literature is shown in Fig. 8. It can be seen, that the proposed controller response appears with reduced settling time and under-shoot as compared to the PID controllers in subject as mentioned in Table 2 (above). The PID controller parameters available in literature are mentioned in Table 3.

Table 3. Comparing PID parameters in literature for single-area power system

| Controller | K_p | K_i | K_d |
|------------|---------|--------|---------|
| PID [21] | 4.2155 | 4.5999 | 0.57889 |
| PID [33] | 0.7900 | 1.4252 | 0.4652 |
| PID [16] | 0.6669 | 1.0185 | 0.2235 |
| PID [34] | 0.06168 | 3.5600 | 0.8900 |
| PID [35] | 1.0000 | 0.2500 | 0.2800 |

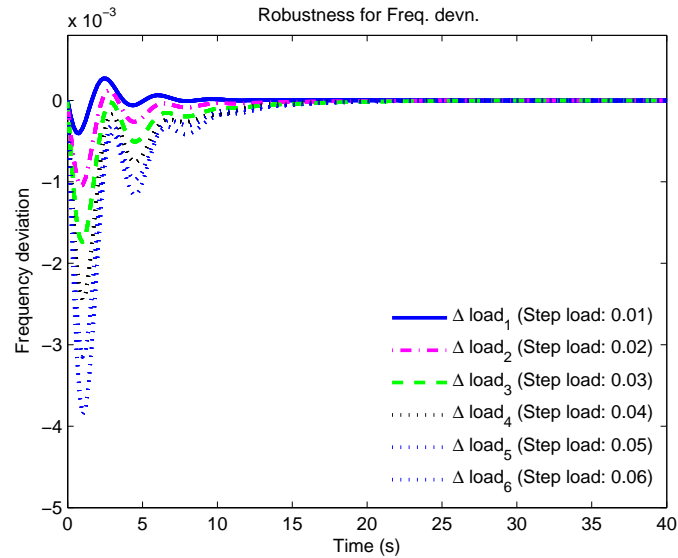

Fig. 7. Frequency deviation of single-area (Δf) for different loading condition

4.2 Two-area system

The frequency and the tie-Line power response of an inter-connected power system is presented using fuzzy logic controller. The frequency deviation ($\Delta f_1, \Delta f_2$) and the tie-line power deviation (ΔP_{12}) of the considered two-area power system is controlled using proposed fuzzy logic controller. The robust operation of the proposed fuzzy logic controller is checked by varying load from 10 % to 70 % load of the both areas and is shown in Fig. 9 - Fig. 10. The tie-line power response for different loading conditions with proposed FLC is shown in Fig. 11. On close observation of these response in Fig. 9 - Fig. 11, it is easy to state that the system is stable for different loading condition of the system.

The comparison of frequency response and tie-Line power of system with proposed fuzzy controller and that of with PID controllers reported in literature is shown in Fig. 12 - Fig. 14. The statistical comparison of the responses in terms of settling-time and under-shoot is shown in Table 5 - Table 7. The PID controller parameters available in literature for two-area system are mentioned in Table 4. It could be easy to say that the proposed intelligent controller settles very fast as compared to PID controller in literature.

Table 4. Comparing PID parameters in literature for two-area power system

| Controller | Area | K_p | K_i | K_d |
|------------|--------|--------|--------|--------|
| PID [20] | Area-1 | 0.1109 | 0.2742 | 0.1110 |
| | Area-2 | 0.0121 | 0.2019 | 0.0030 |
| PID [33] | Area-1 | 0.7900 | 1.4252 | 0.4652 |
| | Area-2 | 0.7674 | 0.1776 | 0.1056 |
| PID [37] | Area-1 | 0.0010 | 0.5350 | 0.1831 |
| | Area-2 | 1.4785 | 1.7496 | 1.0342 |
| PID [38] | Area-1 | 0.3259 | 0.5743 | 0.4024 |
| | Area-2 | 0.3834 | 0.6127 | 0.4021 |
| PID [39] | Area-1 | 0.7005 | 0.3802 | - |
| | Area-2 | 0.7005 | 0.3802 | - |
| PID [4] | Area-1 | 0.6003 | 0.6204 | 0.5224 |
| | Area-2 | 0.3000 | 0.7319 | 0.3654 |

Table 5. Frequency deviation (Δf_1) of two-area for LFC of proposed-fuzzy and PID controller

| Controller | Settling Time | Undershoot |
|------------------|---------------|-----------------------|
| Fuzzy (Proposed) | 12 | -1.4×10^{-4} |
| PID [20] | 32 | -6.4×10^{-4} |
| PID [33] | 44 | -3.5×10^{-4} |
| PID [37] | 27 | -6.1×10^{-4} |
| PID [38] | 28 | -4×10^{-4} |
| PID [39] | 15 | -6.1×10^{-4} |
| PID [4] | - | -3.5×10^{-4} |

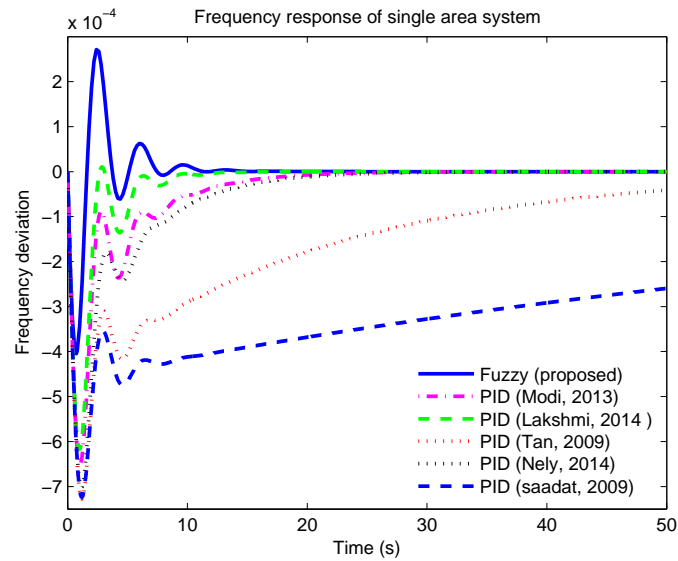

Fig. 8. Frequency deviation of proposed fuzzy logic for single area (Δf) compared with PID controller

Table 6. Frequency deviation (Δf_2) of two-area for LFC of proposed-fuzzy and PID controller

| Controller | Settling Time | Undershoot |
|------------------|---------------|-----------------------|
| Fuzzy (Proposed) | 9 | -2.5×10^{-4} |
| PID [20] | 25 | -6.2×10^{-4} |
| PID [33] | 23 | -9.6×10^{-4} |
| PID [37] | 22 | -8.1×10^{-4} |
| PID [38] | 24 | -5.0×10^{-4} |
| PID [39] | 12 | -5.0×10^{-4} |
| PID [4] | 23 | -3.6×10^{-4} |

Table 7. Tie-Line power deviation (ΔP_{12}) of two-area for LFC of proposed-fuzzy and PID controller

| Controller | Settling Time | Undershoot |
|------------------|---------------|-----------------------|
| Fuzzy (Proposed) | 26 | - |
| PID [20] | 40 | - |
| PID [33] | 44 | - |
| PID [37] | 40 | - |
| PID [38] | 38 | - |
| PID [39] | 30 | -3×10^{-4} |
| PID [4] | 35 | -1.4×10^{-4} |

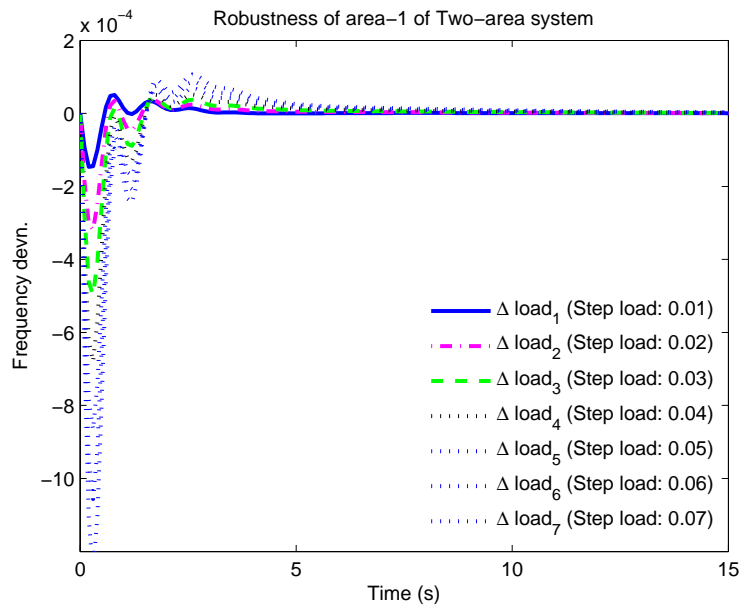

Fig. 9. Frequency deviation of two area (Δf_1) for different loading condition

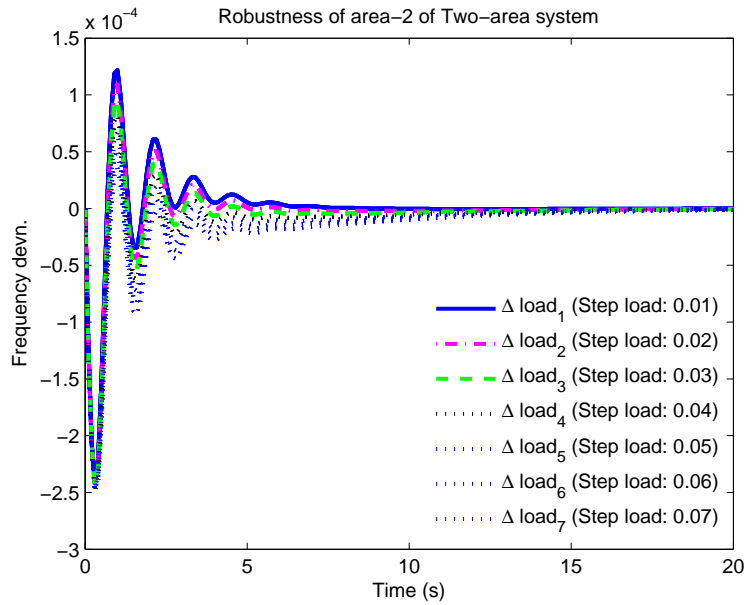

Fig. 10. Frequency deviation of two area (Δf_2) for different loading condition

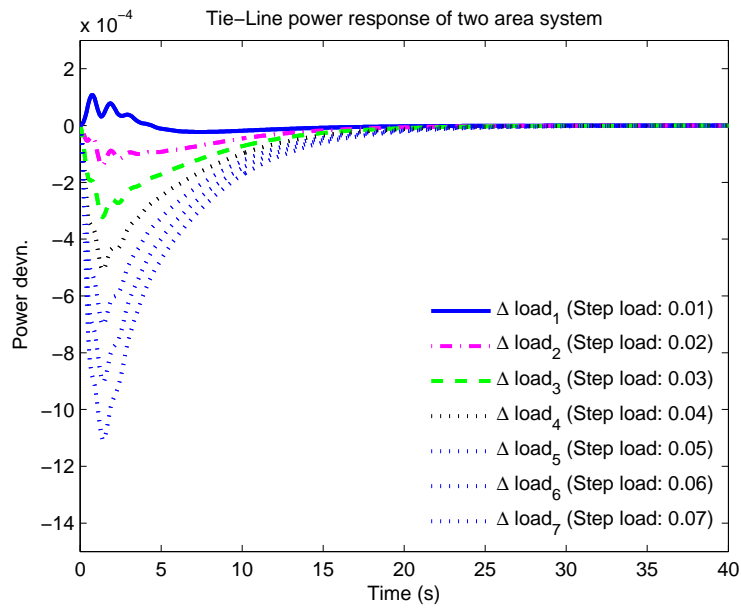

Fig. 11. Tie-line power deviation of two area (ΔP_{12}) for different loading condition

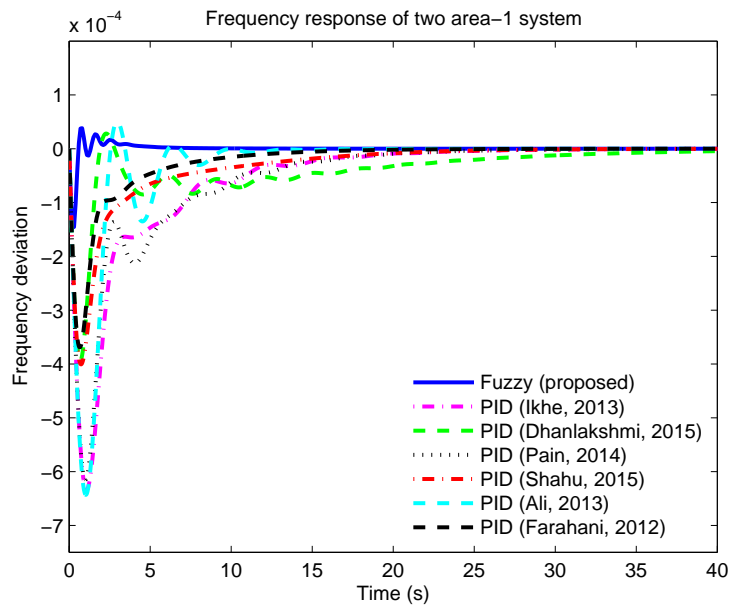

Fig. 12. Frequency deviation of two-area (Δf_1) compared with PID

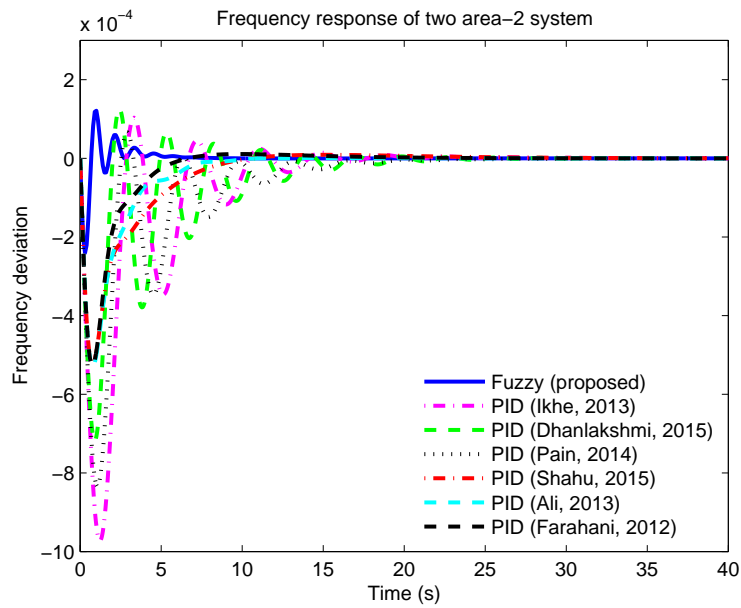

Fig. 13. Frequency deviation of two-area (Δf_2) compared with PID

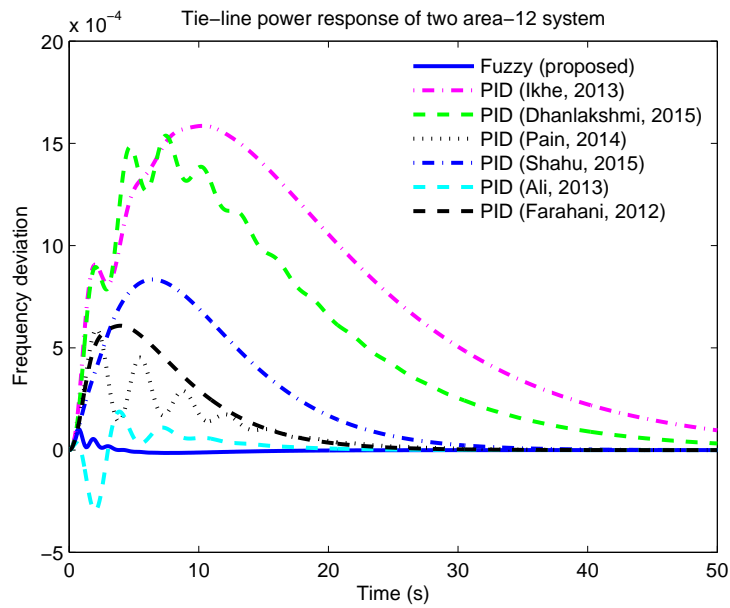

Fig. 14. Power deviation of Tie-line for two-area (ΔP_{12}) compared with PID

5 Conclusion

In this study, fuzzy logic control approach is employed for load frequency control of an isolated system as well as on an inter-connected power system with non-reheat turbine system. The proposed fuzzy controller is reported as with better performance in comparison to PID controllers reported in literature. The system response is compared in terms of rise time and peak value of undershoot. It is found that the system response with fuzzy logic controller better in comparison to the response with PID controllers in literature for single-area as well as two-area systems.

Competing Interests

The authors declare that no competing interests exist.

References

- [1] Usman A, Divakar BP. Simulation study of load frequency control of single and two area systems. In: IEEE Global Humanitarian Technology Conference (GHTC, '12'). 2012;214-219. DOI: 10.1109/GHTC.2012.38
Available:<http://dx.doi.org/10.1109/GHTC.2012.38>
- [2] Yesil E, Gzelkaya M, Eksin I. Self tuning fuzzy PID type load and frequency controller. Energy Conversion and Management. 2004;45(3):377-390.
DOI: [http://dx.doi.org/10.1016/S0196-8904\(03\)00149-3](http://dx.doi.org/10.1016/S0196-8904(03)00149-3)
Available:<http://www.sciencedirect.com/science/article/pii/S0196890403001493>
- [3] Nanda J, Mangla A. Automatic generation control of an interconnected hydro-thermal system using conventional integral and fuzzy logic controller. In: Proceedings of the 2004 IEEE International Conference on Electric Utility Deregulation, Restructuring and Power Technologies, (DRPT 2004). 2004;1:372-377.
DOI: 10.1109/DRPT.2004.1338524
Available:<http://dx.doi.org/10.1109/DRPT.2004.1338524>
- [4] Farahani M, Ganjefar S, Alizadeh M. PID controller adjustment using chaotic optimisation algorithm for multi-area load frequency control. IET - Control Theory Applications. 2012;6(13):1984-1992.
DOI: 10.1049/iet-cta.2011.0405
Available:<http://dx.doi.org/10.1049/iet-cta.2011.0405>
- [5] Khodabakhshian A, Pour ME, Hooshmand R. Design of a robust load frequency control using sequential quadratic programming technique. International Journal of Electrical Power & Energy Systems. 2012;40(1):1-8.
DOI: <http://dx.doi.org/10.1016/j.ijepes.2011.10.018>
Available:<http://www.sciencedirect.com/science/article/pii/S0142061511002675>
- [6] Srinivasa Rao C. Adaptive neuro fuzzy based load frequency control of multi area system under open market scenario. In: International Conference on Advances in Engineering, Science and Management (ICAESM, '12'). 2012;5-10.
- [7] Adaryani M, Afrakhte H. Narma-12 controller for three-area load frequency control. In: 19th Iranian Conference on Electrical Engineering (ICEE,'11). 2011;1-6.
- [8] Zadeh LA. Fuzzy sets. Information Control. 1965;8(0):338-353.
- [9] Mamdani E, Assilian S. An experiment in linguistic synthesis with a fuzzy logic controller. International Journal of Man-Machine Studies. 1975;7(1):1-13.
DOI: [http://dx.doi.org/10.1016/S0020-7373\(75\)80002-2](http://dx.doi.org/10.1016/S0020-7373(75)80002-2)
Available:<http://www.sciencedirect.com/science/article/pii/S0020737375800022>

- [10] Sambariya DK, Gupta R, Sharma A. Fuzzy applications to single machine power system stabilizers. *Journal of Theoretical and Applied Information Technology*. 2009;5(3):317-324.
Available:<http://www.jatit.org>
- [11] Sambariya DK, Gupta R. Fuzzy applications in a multi-machine power system stabilizer. *Journal of Electrical Engineering and Technology*. 2010;5(3):503-510.
Available:<http://www.jeet.or.kr>
- [12] Sambariya DK, Prasad R. Design of harmony search algorithm based tuned fuzzy logic power system stabilizer. *International Review of Electrical Engineering (IREE)*. 2013;8(5):1594-1607.
DOI: 10.15866/iree.v8i5.2117
Available:<http://dx.doi.org/10.15866/iree.v8i5.2117>
- [13] Sambariya DK, Prasad R. Robust power system stabilizer design for single machine infinite bus system with different membership functions for fuzzy logic controller. In: 7th International Conference on Intelligent Systems and Control (ISCO, '13'). 2013;13-19.
DOI: 10.1109/ISCO.2013.6481115
Available:<http://dx.doi.org/10.1109/ISCO.2013.6481115>
- [14] Sambariya DK. Power system stabilizer design using compressed rule base of fuzzy logic controller. *Journal of Electrical and Electronic Engineering*. 2015;3(3):52-64.
DOI: 10.11648/j.jeee.20150303.16
Available:<http://dx.doi.org/10.11648/j.jeee.20150303.16>
- [15] Sambariya DK, Prasad R. Optimal tuning of fuzzy logic power system stabilizer using harmony search algorithm. *International Journal of Fuzzy Systems*. 2015;17(3):457-470.
DOI: 10.1007/s40815-015-0041-4
Available:<http://dx.doi.org/10.1007/s40815-015-0041-4>
- [16] Tan W. Tuning of PID load frequency controller for power systems. *Energy Conversion and Management*. 2009;50(6):1465-1472.
DOI: <http://dx.doi.org/10.1016/j.enconman.2009.02.024>
Available:<http://www.sciencedirect.com/science/article/pii/S0196890409000740>
- [17] Vijaya Santhi R, Sudha K, Prameela Devi S. Robust load frequency control of multi-area interconnected system including smes units using type-2 fuzzy controller. In: IEEE International Conference on Fuzzy Systems (FUZZ'13). 2013;1-7.
DOI: 10.1109/FUZZ-IEEE.2013.6622324
Available:<http://dx.doi.org/10.1109/FUZZ-IEEE.2013.6622324>
- [18] Lee HJ, Park JB, Joo YH. Robust load-frequency control for uncertain nonlinear power systems: A fuzzy logic approach. *Information Sciences*. 2006;176(23):3520-3537.
DOI: <http://dx.doi.org/10.1016/j.ins.2006.01.003>
Available:<http://www.sciencedirect.com/science/article/pii/S0020025506000144>
- [19] Sahu RK, Panda S, Padhan S. A hybrid firefly algorithm and pattern search technique for automatic generation control of multi area power systems. *International Journal of Electrical Power & Energy Systems*. 2015;64:9-23.
DOI: <http://dx.doi.org/10.1016/j.ijepes.2014.07.013>
Available:<http://www.sciencedirect.com/science/article/pii/S0142061514004451>
- [20] Ikhe A, Kulkarni A. Load frequency control for interconnected power system using different controllers automation. *Automation, Control and Intelligent Systems*. 2013;1(4):85-89.
DOI: 10.11648/j.acis.20130104.11
Available:<http://dx.doi.org/10.11648/j.acis.20130104.11>
- [21] Modi N, Khare M, Chaturvedi K. Performance analysis of load frequency control in single area power system using ga and pso based pid controller. *International Journal of Electrical, Electronics and Computer Engineering*. 2013;2(1):108-114.

- [22] Bevrani H, Habibi F, Babahajyani P, Watanabe M, Mitani Y. Intelligent frequency control in an ac microgrid: Online pso-based fuzzy tuning approach. *IEEE Transactions on Smart Grid.* 2012;3(4):1935-1944.
DOI: 10.1109/TSG.2012.2196806
Available:<http://dx.doi.org/10.1109/TSG.2012.2196806>
- [23] Tunstel E, de Oliveira MAA, Berman S. Fuzzy behavior hierarchies for multi-robot control. *International Journal of Intelligent Systems.* 2002;17(5):449470.
DOI: 10.1002/int.10032
Available:<http://dx.doi.org/10.1002/int.10032>
- [24] Torra V. A review of the construction of hierarchical fuzzy systems. *International Journal of Intelligent Systems.* 2002;17(5):531-543.
DOI: 10.1002/int.10036
Available:<http://dx.doi.org/10.1002/int.10036>
- [25] Sambariya DK, Prasad R. Fuzzy pss for single machine infinite bus power system. In: *International Conference on Power Electronics and Energy Systems (PEES-2012).* Department of Electrical Engineering, Chitkara University. 2012;23-27: ISBN: 978-81-920249-8-1.
- [26] Sambariya DK. Power system stabilizer with fuzzy logic for multi-machine system. In: *National Conference on Power and Energy Systems, (NCPES-2011).* 2011;200-204.
- [27] Venkatraman E, Velusami S, Ansari M, Ganapathy S. Design of type - 2 fuzzy logic load frequency controller for two area thermal reheat power systems. In: *International Conference on Computing, Electronics and Electrical Technologies (ICCEET, '12')*. 2012;180-185.
DOI: 10.1109/ICCEET.2012.6203909
Available:<http://dx.doi.org/10.1109/ICCEET.2012.6203909>
- [28] Zenk H, Zenk O, Akpınar A. Two different power control system load-frequency analysis using fuzzy logic controller. In: *International Symposium on Innovations in Intelligent Systems and Applications (INISTA, '11')*. 2011;465-469.
DOI: 10.1109/INISTA.2011.5946146
Available:<http://dx.doi.org/10.1109/INISTA.2011.5946146>
- [29] Sambariya DK, Gupta R. Fuzzy logic based robust multi-machine power system stabilizer. In: *International Conference on Computer Applications in Electrical Engineering Recent Advances, (CERA-2005).* 2005;436-442.
- [30] Sambariya DK, Gupta R: Fuzzy logic based power systems stabilizer for kota thermal power station. In: *International Conference on Computers, Controls and Communication (INCON-CCC-2004).* 2004;307-316.
- [31] Sambariya DK, Gupta R. Fuzzy logic based power system stabilizer for multi-machine system. In: *Thirteenth, National Power Systems Conference (NPSC-2004).* 2004;257-261.
- [32] Anand B, Jeyakumar A. Load frequency control of interconnected hydro-hydro system with fuzzy logic controller. In: *International Conference on Process Automation, Control and Computing (PACC, '11')*. 2011;1-4.
DOI: 10.1109/PACC.2011.5978879
Available:<http://dx.doi.org/10.1109/PACC.2011.5978879>
- [33] Dhanalakshmi P, Mahadevan K. Assessment of optimal pid tuning controllers for load frequency control. *Wseas Transactions on Power Systems.* 2015;10;116-121.
- [34] Kouba N, Mena M, Hasni M, Boussahoua B, Boudour M. Optimal load frequency control in interconnected power system using pid controller based on particle swarm optimization. In: *International Conference on Electrical Sciences and Technologies in Maghreb (CISTEM'14).* 2014;1-8.
DOI: 10.1109/CISTEM.2014.7077013
Available:<http://dx.doi.org/10.1109/CISTEM.2014.7077013>

- [35] Saadat H. Power system analysis. 3rd edition. PSA Publishing LLC; 2011.
- [36] Nath V, Sambariya DK. Analysis of agc and avr for single area and double area power system using fuzzy logic control. *International Journal of Advanced Research in Electrical, Electronics and Instrumentation Engineering*. 2015;4(7): 6501-6511.
DOI: 10.15662/ijareeie.2015.0407075
Available:<http://dx.doi.org/10.15662/ijareeie.2015.0407075>
- [37] Pain S, Acharjee P. Multiobjective optimization of load frequency control using pso. *International Journal of Emerging Technology and Advanced Engineering*. 2014;4(7):16-22.
- [38] Sahu RK, Panda S, Pradhan PC. Design and analysis of hybrid firefly algorithm-pattern search based fuzzy PID controller for LFC of multi area power systems. *International Journal of Electrical Power & Energy Systems*. 2015;69:200-212.
DOI: <http://dx.doi.org/10.1016/j.ijepes.2015.01.019>
Available:<http://www.sciencedirect.com/science/article/pii/S0142061515000381>
- [39] Ali E, Abd-Elazim S. BFOA based design of PID controller for two area load frequency control with nonlinearities. *International Journal of Electrical Power & Energy Systems*. 2013;51:224-231.
DOI: <http://dx.doi.org/10.1016/j.ijepes.2013.02.030>
Available:<http://www.sciencedirect.com/science/article/pii/S0142061513000902>

Appendix

Data for area-1 of two-area system

$R_1 = 0.005$, $D_1 = 0.60$, $H_1 = 5.0$, $BasePower = 1000MVA$, $T_{g1} = 0.20$, $T_{i1} = 0.50$, $B_1 = 20.1$

Data for area-2 of two-area system

$R_2 = 0.0625$, $D_2 = 0.90$, $H_2 = 4.0$, $BasePower = 1000MVA$, $T_{g2} = 0.30$, $T_{i2} = 0.60$, $B_2 = 16.90$

©2016 Sambariya and Nath; This is an Open Access article distributed under the terms of the Creative Commons Attribution License (<http://creativecommons.org/licenses/by/4.0>), which permits unrestricted use, distribution, and reproduction in any medium, provided the original work is properly cited.

Peer-review history:

The peer review history for this paper can be accessed here (Please copy paste the total link in your browser address bar)

<http://sciencedomain.org/review-history/12821>